



HL-4300L Series

An innovative new lockset.

Hyundai Metal is well known worldwide
as a manufacturer of quality Door Locks.

Hyundai

- It is the ideal lever lockset for light commercial and residential applications
- Heavy duty lever spring return rose assembly



HL-4300L (Flair) ENT PB

Door Preparation

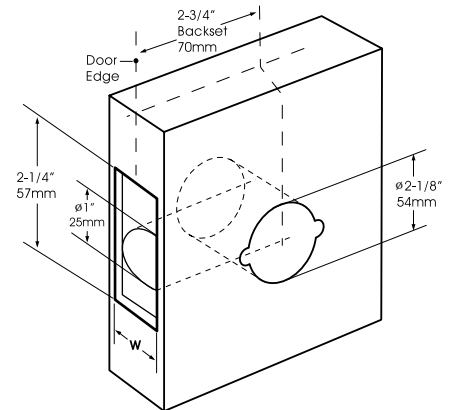

Type 4300L cutout × K203-G3 strike

W - Standard Front : 1" (25mm) × 2 1/4" (57mm)
Wide Front : 1 1/8" (29mm) × 2 1/4" (57mm)

Specifications

Applications	For interior offices, multi-family housing, restaurants, hotels, retail complexes
For Doors	1 3/8" to 1 3/4" (35mm to 45mm)
Backset	2 3/8" (60mm) or 2 3/4" (70mm) standard Adjustable, 3 3/8" (85mm), 5" (127mm) optional
Front	Brass, Bronze ; 2 1/4" × 1" standard 2 1/4" × 1 1/8" optional
Strike	Brass, Bronze ; K203-G3 strike standard K203-G3 (Long-lip), Full-lip, ASA, K203-G2 (Anti-rattle), K203-G2 strikes optional
Roses	Brass or Bronze
Hand	Right or Left hand must be specified for "Lido" and "Flair" designs (Handed will be solved when reversing In/Outside levers for Entrance, Privacy and Passage functions)
Latchbolt	Zinc, 7/16" throw standard Brass, 7/16" throw optional (except Adjustable Backset)
Keys	Three, Brass standard ("L", "R", "E" levers) - Kwikset 5 pin Two, Brass standard ("Lido", "Flair" levers) - Schlage 6 pin
Cylinder Body	Zinc, Kwikset 5 pin standard ("L", "R", "E" levers) Brass, Schlage 6 pin standard ("Lido", "Flair" levers) All levers available with Weiser, Arrow, Lockwood C 4, Schlage optional
Cylinder Plug	Brass
Masterkeying	Can be masterkeyed or grand masterkeyed Construction key system available
Finishes (US Code)	3, 4, 5A, 10, 10B, 11, 15, 15A, 19, 26, 26D
Split Finishes	Outside finish specified first. Front & Strike finished to match inside trim unless otherwise specified

Lever Designs

'Flair' lever

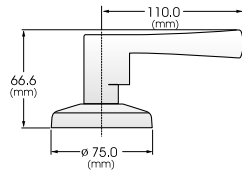

Lever : Zinc cast
Rose : Brass or Bronze

Right or Left hand must be specified.
Right hand furnished unless otherwise specified.
(Handed will be solved when reversing In/Outside levers for Entrance, Privacy and Passage functions)

'Lido' lever

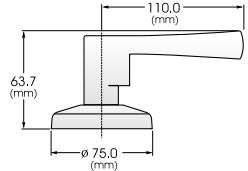

Lever : Zinc cast
Rose : Brass or Bronze

Right or Left hand must be specified.
Right hand furnished unless otherwise specified.
(Handed will be solved when reversing In/Outside levers for Entrance, Privacy and Passage functions)

'L' lever

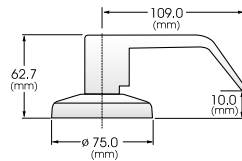

Lever : Zinc cast
Rose : Brass or Bronze

Complies with codes requiring lever to return to within 1/2" of door face

'R' lever

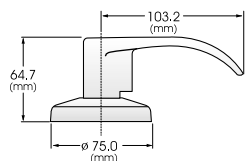

Lever : Zinc cast
Rose : Brass or Bronze

'E' lever

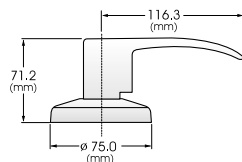

Lever : Zinc cast
Rose : Brass or Bronze

Finishes

HD CODE	DESCRIPTIONS	US CODE	BHMA
PB	Polished Brass	3	605
SB	Satin Brass	4	606
AB	Antique Brass	5A	610
SBZ	Satin Bronze	10	612
OBZ	Oxidized Bronze, Oil Rubbed	10B	613
AC	Antique Copper	11	616
SN	Satin Nickel Plated	15	619
AN	Antique Nickel Plated	15A	620
EB	Ebony Brass	19	622
PCR	Polished Chromium Plated	26	625
SCR	Satin Chromium Plated	26D	626

Zinc levers are plated to match BHMA finish.
Custom colors available, consult factory.
(Specify quantity, functions and US finish.)

Latches

To order latchbolt separately, specify Part No. x Finish

Backset	Descriptions (Square Corner standard)	Part Number	
		Deadlatch	Springlatch
2 3/8" (60mm)	1 1/8" (29mm) × 2 1/4" (57mm)	ENT-WD/60	PRI-WD/60
	1" (25mm) × 2 1/4" (57mm)	ENT-STD/60	PRI-STD/60
	1" (25mm) Drive-in	ENT-DR/60	PRI-DR/60
2 3/4" (70mm)	1 1/8" (29mm) × 2 1/4" (57mm)	ENT-WD/70	PRI-WD/70
	1" (25mm) × 2 1/4" (57mm)	ENT-STD/70	PRI-STD/70
	1" (25mm) Drive-in	ENT-DR/70	PRI-DR/70
Adjustable (2 3/8" ↔ 2 3/4")	1 1/8" (29mm) × 2 1/4" (57mm)	ENT-WD/ADJ	PRI-WD/ADJ
	1" (25mm) × 2 1/4" (57mm)	ENT-STD/ADJ	PRI-STD/ADJ
3 3/8" (85mm)	1 1/8" (29mm) × 2 1/4" (57mm)	ENT-WD/85	PRI-WD/85
	1" (25mm) × 2 1/4" (57mm)	ENT-STD/85	PRI-STD/85
5" (127mm)	1 1/8" (29mm) × 2 1/4" (57mm)	ENT-WD/127	PRI-WD/127
	1" (25mm) × 2 1/4" (57mm)	ENT-STD/127	PRI-STD/127
Round Corner Latches available on request			

Latch Front Adapter

Used to convert 1" wide square front faceplates for 1 1/8" wide door preparations. Furnished in white plastic.

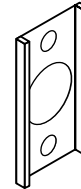

Long Backsets

Backsets 5" extension links.

Long backsets are normally furnished with 1" faceplates and 7/8" housings.

5" Extension Link

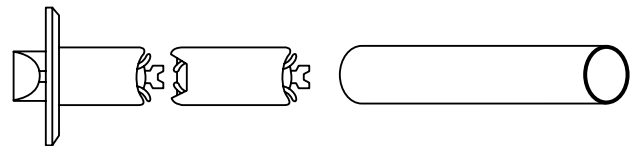

Square Corner Latches

Springlatch

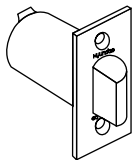

Deadlatch

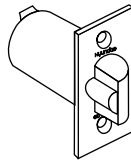

Round Corner Latches

Springlatch

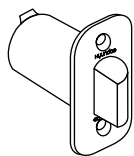

Deadlatch

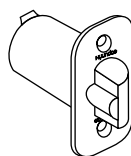

Drive-In Latches

Springlatch

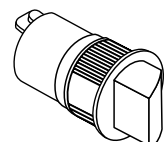

Deadlatch

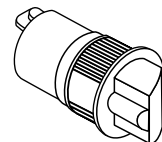

Latch Sleeve

Included with 2 3/8" backset latches to fill 1" edge bores (optional).

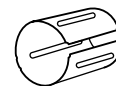

Pop-off function

Locked button is released by closing door.

Use for Privacy function only.

To order pop-off function latch, specify springlatch with pop-off function.

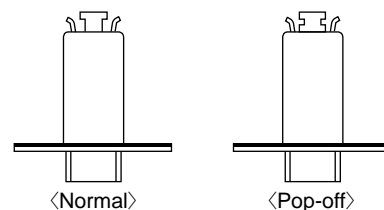

Strike Parts

No.K203-G3 strike (standard)

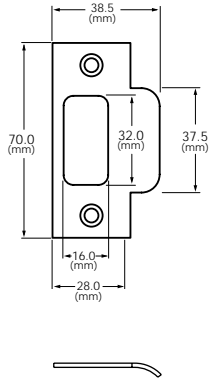

No.K203-G3 Long-lip strike

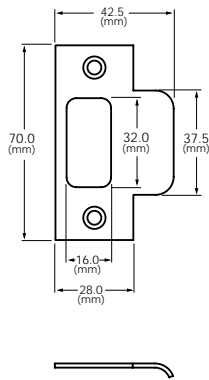

No.K203-G3 Round-corner strike

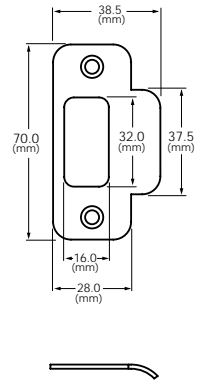

No.U203 Full-lip strike

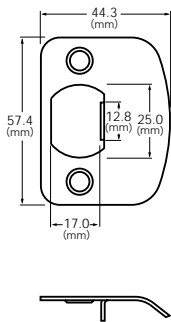

No.D203 Full-lip strike

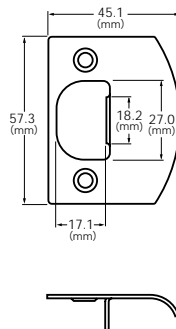

No.U204 Full-lip strike

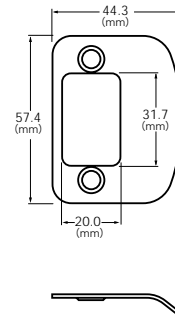

No.K203-G2 strike

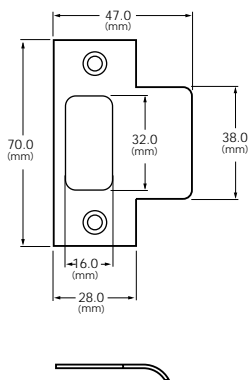

No. K203-G2 (Anti-rattle) strike

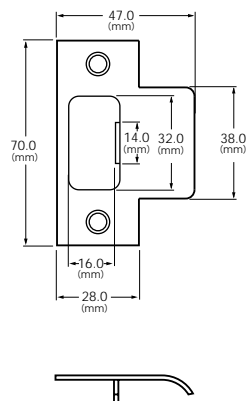

How To Order

Hyundai Line	HL
Model	4300L
Lever Type	Flair
Handed	RH
Function	ENT
Finish	PB
Backset	STD / 60
Q'ty	100

Sample :
HL- 4300L (Flair)RH ENT PB STD/60 - 100 sets

Functions

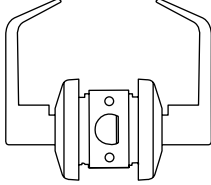
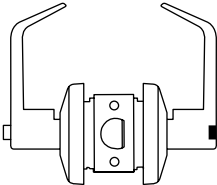
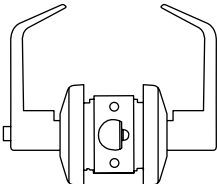
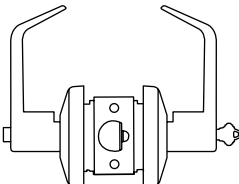
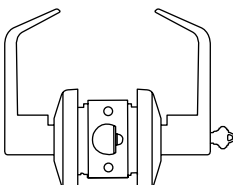
Inside	Outside	Type	ANSI	Function Description
		Passage	HF 75	<ul style="list-style-type: none"> · Latchbolt by lever either side. · Both levers always free.
		Privacy Bedroom or Bathroom	HF 76	<ul style="list-style-type: none"> · Latchbolt by lever either side, except when push button locks outside lever. · Outside lever locked by push button. · Outside lever unlocked by emergency release tools by rotating inside lever. · Inside lever always free. · Pop-off function available on request.
		Patio or Privacy	HF 77	<ul style="list-style-type: none"> · Deadlocking latchbolt by lever either side except when push button locks outside lever. · Outside lever locked by push button. · Outside lever unlocked by rotating inside lever. · Inside lever always free. · Should not be used in rooms that have no other entrance.
		Entrance or Office	HF 81	<ul style="list-style-type: none"> · Deadlocking latchbolt by either side except when push button locks outside lever. · Pushing button locks outside lever, requiring use of key outside to unlock. · Turning inside lever unlocks outside lever. · Key retracts latchbolt when outside lever is locked. · Inside lever always free.
		Classroom	HF 84	<ul style="list-style-type: none"> · Deadlocking latchbolt by lever either side except when key outside locks outside lever. · Key in outside lever locks or unlocks outside lever. · Inside lever always free.

Functions

Inside	Outside	Type	ANSI	Function Description
		Storeroom	HF 86	<ul style="list-style-type: none"> · Deadlocking latchbolt by key in outside lever or rotating inside lever. · Outside lever always locked · Inside lever always free.
		Communicating (Classroom)	HF 88	<ul style="list-style-type: none"> · key in either lever locks or unlocks its own lever independently.
		Half Dummy Trim	-	<ul style="list-style-type: none"> · Lever acts as pull only; no operation.

 Indicates rigid lever.

Button types

- Push Button standard
- Push & Turn Button, Universal Turn Button optional



Main Factory :

#720, Daecheon-dong, Dalseo-gu, Daegu, Korea.

Tel No. : 82-53-586-9719, 82-53-589-9840~3

Fax No. : 82-53-587-5890

Http:// www.hyundaelock.com

E-mail : hyundaelock@hyundaelock.com